

**TEST REPORT**

**Engineering Recommendation G98 Issue 1 Amendment 4 June 2019  
Requirements for the connection of Fully Type Tested Micro-generators (up to and including 16 A per phase) in parallel with public Low Voltage Distribution Networks**

**Report reference No.**..... : 190114150GZU-001  
**Tested by** ..... Jason Fu  
 (printed name and signature) ..... : Senior Project Engineer *Jason Fu*  
**Approved by** ..... Tommy Zhong  
 (printed name and signature) ..... : Technical Manager *Tommy Zhong*  
**Date of issue** ..... : 18 April 2019, Revision 1: 29 Aug 2019  
 40 pages

**Testing Laboratory Name** ..... : Intertek Testing Services Shenzhen Ltd. Guangzhou Branch  
**Address** ..... : Block E, No.7-2 Guang Dong Software Science Park, Caipin Road,  
 Guangzhou Science City, GETDD, Guangzhou, China  
**Testing location** ..... : Same as above  
**Address** ..... : Same as above

**Applicant's Name** ..... : Shenzhen SOFAR SOLAR Co., Ltd.  
**Address** ..... : 401, Building 4, AnTongDa Industrial Park, District 68, XingDong  
 Community, XinAn Street, BaoAn District, Shenzhen, China

**Test specification**  
**Standard**..... : G98 Issue 1 Amendment 4 June 2019  
**Test procedure** ..... : Type Verification  
**Non-standard test method** ..... : N/A

**Test Report Form No.** ..... : G98/1b  
**TRF originator** ..... : Intertek  
**Master TRF** ..... : dated 2019-06

**Test item description** ..... : Hybrid Inverter  
**Trademark** ..... :   
**Manufacturer** ..... : Same as applicant  
**Factory** ..... : Dongguan SOFAR SOLAR Co., Ltd.  
 1F-6F, Building E, No.1 JinQi Road, Bihu Industrial Park, Wulian Village,  
 Fenggang Town, Dongguan City  
**Model and/or type reference** ..... : ME 3000SP

Rating(s)..... :	Battery Type: Lead-acid, Lithium-ion Battery Voltage Range: 42-58Vdc Max. Charging Current: 60A Max. Discharging Current: 60A Max. Charging & Discharging Power: 3000VA Nominal Grid Voltage: 230Vac Nominal output Voltage (stand-alone): 230Vac Max. output Current: 13A Nominal Grid frequency: 50Hz Power factor: 1 (adjustable +/-0.8) Ingress protection: IP65 Operating Temperature Range: -25°C - 60°C Protective Class: Class Software Version: V1.00
------------------	---

Summary of testing:

The sample(s) tested complied with the type test requirement of G98 Issue 1 Amendment 4 June 2019

**Test case verdicts**

Test case does not apply to the test object .: N/A  
Test item does meet the requirement .....: P(ass)  
Test item does not meet the requirement ....: F(ail)

**Testing**

Date of receipt of test item .....: 28 Aug 2019  
Date(s) of performance of test .....: 28 Aug 2019

**General remarks**

The test results presented in this report relate only to the object tested.  
This report shall not be reproduced, except in full, without the written approval of the Issuing testing laboratory.  
"(See Enclosure #)" refers to additional information appended to the report.  
"(See appended table)" refers to a table appended to the report.

Throughout this report a point is used as the decimal separator.

When determining the test conclusion, the Measurement Uncertainty of test has been considered.

This report is for the exclusive use of Intertek's Client and is provided pursuant to the agreement between Intertek and its Client. Intertek's responsibility and liability are limited to the terms and conditions of the agreement. Intertek assumes no liability to any party, other than to the Client in accordance with the agreement, for any loss, expense or damage occasioned by the use of this report. Only the Client is authorized to permit copying or distribution of this report and then only in its entirety. Any use of the Intertek name or one of its marks for the sale or advertisement of the tested material, product or service must first be approved in writing by Intertek. The observations and test results in this report are relevant only to the sample tested. This report by itself does not imply that the material, product, or service is or has ever been under an Intertek certification program.

The test report only allows to be revised only within the report defined retention period unless standard or regulation was withdrawn or invalid.

**Revision 1:**

**This report is based on and superseded original report No.190114150GZU-001, dated 18 April 2019 due to the following reason:**

- 1, Re-tested Limited Frequency Sensitive Mode and update the testing data.**
- 2, Updated the standard from G98/1-3 to G98/1-4.**

**General product information:**

The equipment under test is single phase energy storage inverter. They are responsible for converting the direct current generated by battery into single-phase 230V, 50 Hz. A high frequency transformer and relay are providing basic insulation between grid and battery. Hence, the mechanical disconnection device (relay) is provided between grid and battery on line and neutral conductor and off-grid in case of single fault occurs.

The topology diagram as following:

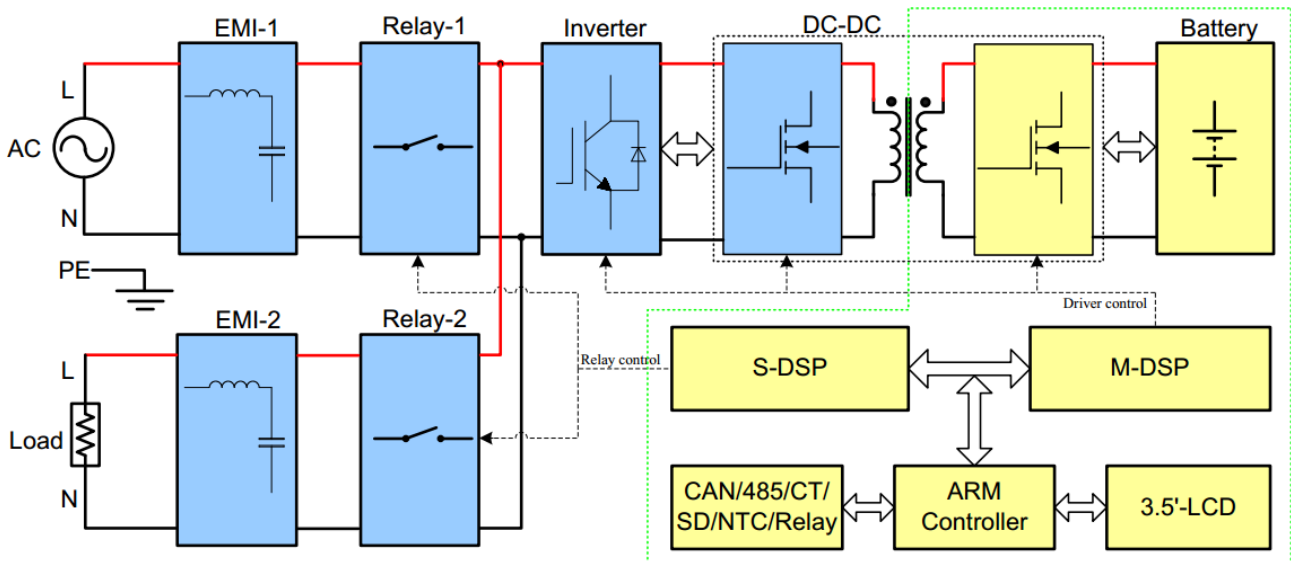

The equipments have three working mode. Charge mode, Discharge mode, Stand-alone mode :

Charge mode: The AC voltage from mains charges the battery provided in the final system.

Discharge mode: The inverter converts the energy from the battery to 230Va.c.,50 Hz voltage and connected to AC mains. In this mode the inverter works as grid connected inverter.

Stand-alone mode: The inverter converter the energy from the battery to 230Va.c.,50 Hz voltage and feed the general load. In this mode the inverter worked as stand-alone inverter.

**The product was tested on:**

The Software version: V1.00

The Hardware version: V1.00









Copy of marking plate:



**AC-Coupled Storage Converter**

<b>Model No:</b>	<b>ME 3000SP</b>
Battery Type	Lead-acid, Lithium-ion
Battery Voltage Range	42-58Vdc
Max. Charging Current	60A
Max. Discharging Current	60A
Max. Charging & Discharging Power	3000VA
Nominal Grid Voltage	230Vac
Nominal Output Voltage	230Vac
Max. Output Current	13A
Nominal Grid Frequency	50/60Hz
Power Factor	1 (adjustable +/- 0.8)
Ingress Protection	IP65
Operating Temperature Range	-25+60°C
Protective Class	Class I

Manufacturer : Shenzhen SOFAR SOLAR Co., Ltd.  
 Address : 401, Building 4, AnTongDa Industrial Park,  
 District 68, XingDong Community, XinAn Street,  
 BaoAn District, Shenzhen, China  
 SAA162631  
 VDE0126-1-1, VDE-AR-N4105, G98, EN50438,  
 AS4777, UTE C15-712-1

**Note:**

1. The above markings are the minimum requirements required by the safety standard. For the final production samples, the additional markings which do not give rise to misunderstanding may be added.
2. Label is attached on the side surface of enclosure and visible after installation.

<b>Engineering recommendation G98/1</b>			
Clause	Requirement – Test	Result – Remark	Verdict
5	Connection Procedure		N/A
5.1	Single Premises Connection Procedure		N/A
5.2	Multiple Premises Connection Procedure		N/A
6	Certification Requirements		P
6.1	Type Test Certification		P
6.1.1	Type Tested certification is the responsibility of the Manufacturer. The Manufacturer shall make available upon request a Type Test Verification Report confirming that the Micro-generator has been tested to satisfy the requirements of this EREC G98. The report shall detail the type and model of Micro-generator tested, the test conditions and results recorded. All of these details shall be included in a Type Test Verification Report. The required verification report and declaration are shown in Appendix 3 Form C. It is intended that Manufacturers of Micro-generators will use the requirements of this EREC G98 to develop type verification certification for each of their Micro-generator models.		P
6.1.2	Manufacturers of a Fully Type Tested Micro-generator should allocate a Manufacturer's reference number with the required details of the Micro-generator with the Energy Networks Association Type Test Verification Report Register.		P
6.2	Compliance		P
6.2.1	Compliance with the requirements detailed in this EREC G98 will ensure that the Micro-generator(s) is considered to be approved for connection to the DNO's Distribution Network.		P
6.2.2	The Micro-generator(s) shall conform to all relevant European Directives and should be labelled with a CE marking.		P
7	Operation and Safety		N/A
8	Commissioning, Notification and Decommissioning		N/A
9	General Technical Requirements		P
9.1	Frequency withstand		P
9.1.1	The Micro-generator shall be capable of remaining connected to the Distribution Network and operating within the frequency ranges and time periods specified in Table 1 unless disconnection was triggered by rate-of-change-of-frequency-type loss of mains protection.		P
9.2	Rate of Change of Frequency		P
9.2.1	With regard to the rate of change of frequency withstand capability, a Micro-generator shall be capable of staying connected to the Distribution Network and operate at rates of change of frequency up to 1.0 Hzs-1 measured over 500 ms.		P
9.3	Limited Frequency Sensitive Mode – Overfrequency		P

<b>Engineering recommendation G98/1</b>			
Clause	Requirement – Test	Result – Remark	Verdict
9.3.1	With regard to the Limited Frequency Sensitive Mode — Overfrequency (LFSM-O), the Micro-generator shall be capable of activating the provision of Active Power Frequency Response according to EN 50438. The GB specific standard frequency threshold shall be 50.4 Hz; the Droop setting shall be 10%. No intentional delay should be programmed to ensure that the initial delay is as short as possible with a maximum of 2 s.	No intentional delay setting	P
9.3.2	The Micro-generator will continue to reduce power with rising frequency with a Droop of 10% until 52.0 Hz, at which point the Micro-generator should disconnect.		P
9.4	Active Power Output		P
9.4.1	The Micro-generator shall be capable of maintaining constant output at its Registered Capacity regardless of changes in frequency, except where the output follows the changes defined in the context of paragraphs 9.3.1 and 9.4.2.		P
9.4.2	The Micro-generator shall be capable of maintaining constant output at its Registered Capacity regardless of changes in frequency in the range 49.5 – 50.4 Hz. Below 49.5 Hz, the power output should not drop by more than pro-rata with frequency, ie the maximum permitted requirement is 100% power at 49.5 Hz falling linearly to 95% power at 47.0 Hz as illustrated in Figure 2.		P
9.4.3	The Micro-generator shall be equipped with a logic interface (input port) in order to cease Active Power output within 5 s following an instruction being received from the DNO at the input port. By default the logic interface will take the form of a simple binary output that can be operated by a simple switch or contactor. When the switch is closed the Micro-generator can operate normally. When the switch is opened the Micro-generator will reduce its Active Power to zero within 5 s. The signal from the Micro-generator that is being switched can be either AC (maximum value 240 V) or DC (maximum value 110 V). The DNO may specify any additional requirements particularly regarding remote operation of this facility.	RJ 45 interface is used for logic interface (input port), nevertheless, the logic interface can also be installed in the end system.	P
9.5	Power Factor	A Fixed power factor at range 0.95 lagging to 0.95 leading	P
9.5.1	The power factor capability of the Micro-generator shall conform to EN 50438. When operating at Registered Capacity the Micro-generator shall operate at a power factor within the range 0.95 lagging to 0.95 leading relative to the voltage waveform unless otherwise agreed with the DNO eg for power factor improvement.	A Fixed power factor at range 0.95 lagging to 0.95 leading	P
9.6	Automatic Connection		P

<b>Engineering recommendation G98/1</b>			
Clause	Requirement – Test	Result – Remark	Verdict
9.6.1	Micro-generators shall conform to EN 50438 in respect of connection and starting to generate electric power. This includes automatic reconnection where the minimum observation time shall be as stated in Annex A12 of EN 50438.		P
10	Interface Protection		P
10.1	General		P
10.1.1	The Micro-generator shall conform to the Interface Protection settings set out below (Table 2). Means shall be provided to protect the settings from unpermitted interference (eg via a password or seal).	The settings for interface shall require a password or authored by manufactures	P
10.1.2	The DNO is responsible under the Distribution Code for ensuring, by design, that the voltage and frequency at the Connection Point remains within statutory limits. The Interface Protection settings have been chosen to allow for voltage rise or drop within the Customer's Installation and to allow the Micro-generator to continue to operate outside of the statutory frequency range as required by the EU Network Code on Requirements for Grid Connection of Generators.		P
10.1.3	Interface Protection shall be installed which disconnects the Micro-generator from the DNO's Distribution Network when any parameter is outside of the settings shown in Table 2.		P
10.1.4	The total disconnection time for voltage and frequency protection, including the operating time of the disconnection device, shall be the time delay setting with a tolerance of, -0s + 0.5 s.		P
10.1.5	For the avoidance of doubt, where the Distribution Network voltage or frequency exceed the trip settings in Table 2, for less than the time delay setting, the Micro-generator should not disconnect from the Distribution Network.		P
10.1.6	Fully Type Tested Micro-generators shall have protection settings set during manufacture.		P



<b>Engineering recommendation G98/1</b>			
Clause	Requirement – Test	Result – Remark	Verdict
10.1.7	<p>The Manufacturer shall establish a secure way of displaying the Interface Protection setting information in one of the following ways:</p> <ul style="list-style-type: none"> <li>● A display on a screen;</li> <li>● A display on a PC which can communicate with the Micro-generator and confirm that it is the correct Micro-generator by means of a serial number permanently fixed to the Micro-generator and visible on the PC screen at the same time as the settings; or</li> <li>● Display of all Interface Protection settings and nominal voltage and current outputs, alongside the serial number of the Micro-generator, permanently fixed to the Micro-generator.</li> </ul>		P
10.1.8	<p>The provision of loose documents, documents attached to the Micro-generator by cable ties etc, or provision of data on adhesive paper based products which are not likely to survive due to fading, or failure of the adhesive, for at least 20 years is not acceptable.</p>		P
10.1.9	<p>In response to a protection operation the Micro-generator shall be automatically disconnected from the DNO's Distribution Network. This disconnection must be achieved preferably by the separation of mechanical contacts or alternatively by the operation of a suitably rated solid state switching device. Where a solid state switching device is used to afford disconnection of the Micro-generator, the switching device shall incorporate fail safe monitoring to check the voltage level at its output stage. In the event that the solid state switching device fails to disconnect the Micro-generator, the voltage on the output side of the switching device shall be reduced to a value below 50 V within 0.5 s of the protection and trip delay timer operation.</p>	Disconnected by relay	P
10.1.10	<p>Where a common protection system is used to provide the protection function for multiple Micro-generators the complete installation cannot be considered to comprise Fully Type Tested Micro-generators if the protection and connections are made up on site and so cannot be factory tested or Fully Type Tested. In accordance with Annex A1 or Annex A2 if the units or Micro-generators are specifically designed with plugs and sockets to be interconnected on site, then provided the assembly passes the function tests required in Appendix 3 Form C, the Micro-generator(s) can retain Fully Type Tested status.</p>		N/A

<b>Engineering recommendation G98/1</b>			
Clause	Requirement – Test	Result – Remark	Verdict
10.1.11	Once the Micro-generator has been installed and commissioned the protection settings shall only be altered following written agreement between the DNO and the Customer or their agent.		N/A
10.2	Loss of Mains Protection		P
10.2.1	Loss of mains protection shall be incorporated and tested as defined in the compliance type testing annex of EN 50438. Active methods which use impedance measuring techniques by drawing current pulses from or injecting AC currents into the DNO's Distribution Network are not considered to be suitable. For Micro-generators which generate on more than one phase, the loss of mains protection should be able to detect the loss of a single phase of the supply network. This should be tested during type testing and recorded in the Type Test Verification Report as per Appendix 3 Form C.		P
10.3	Frequency Drift and Step Change Stability Test		P
10.3.1	Under normal operation of the Distribution Network, the frequency changes over time due to continuous unbalance of load and generation or can experience a step change due to the loss of a Distribution Network component which does not cause a loss of supply.		P
10.3.2	In order to ensure that such phenomena do not cause unnecessary tripping of Micro-generators, stability type tests shall be carried out.		P
10.3.3	The Rate of Change of Frequency (RoCoF) and Vector Shift values required for these tests are marginally less than the corresponding protection settings for RoCoF in Table 2 and vector shifts of up to 50°. Both stability tests shall be carried out in all cases.		P
10.3.4	The stability tests are to be carried out as per the table in Appendix 3 Form C of this document and the Micro-generator should remain connected during each and every test. The tests shall check that the Micro-generator remains stable and connected during the following scenarios: <ul style="list-style-type: none"> <li>● RoCoF: 0.95 Hzs-1 from 49.0 Hz to 51.0 Hz on both rising and falling frequency; and</li> <li>● Vector shift: 50° plus from 49.5 Hz and 50° minus from 50.5 Hz.</li> </ul>		P
11	Quality of Supply		P
11.1	The power quality requirements set out in EN 50438 should be met along with the requirements described in this section of EREC G98.		P

<b>Engineering recommendation G98/1</b>			
Clause	Requirement – Test	Result – Remark	Verdict
11.2	Micro-generators are likely to be installed in large numbers on LV Distribution Networks. They are likely to operate for long periods with no diversity between them, and adjacent Micro-generators are likely to be of the same technology. Therefore, in order to accommodate a high number of Micro-generators on a Distribution Network, procedures are specified in Annex A1 and Annex A2, which need to be applied when testing for harmonic current emissions and flicker.		P
11.3	The requirements of EN 50438 shall be met for DC injection.		P
12	Short Circuit Current Contribution.		P
12.1	Directly Coupled Micro-generators		N/A
12.2	Inverter Connected Micro-generators		P
Appendix 1	Emerging Technologies and other Exceptions		N/A
Appendix 2	Connection Procedure Flow Chart		N/A
Appendix 3	Micro-generator Documentation		N/A
Appendix 4	Relaxation of Commissioning Notification Timescales for Micro-generator: HSE Certificate of Exemption (August 2008)		N/A
A1	Annex A1 Requirements for Type Testing of Inverter Connected Micro-generators		P
A1.2	Type Verification Functional Testing of the Interface Protection		P
A1.2.1	Disconnection times		P
A1.2.2	Over / Under Voltage		P
A1.2.3	Over / Under Frequency		P
A1.2.4	Loss of Mains Protection		P
A1.2.5	Reconnection		P
A1.2.6	Frequency Drift and Step Change Stability test		P
A1.2.7	Active power feed-in at under-frequency		P
A1.2.8	Power response to over-frequency		P
A1.3	POWER QUALITY		P
A1.3.1	Harmonics		P
A1.3.2	Power Factor		P
A1.3.4	DC Injection for Inverters		P
A1.3.5	Short Circuit Current Contribution for Inverters		P
A1.3.6	Self-Monitoring - Solid State Disconnection		N/A
A1.3.7	Electromagnetic Compatibility (EMC)		P

<b>Engineering recommendation G98/1</b>			
Clause	Requirement – Test	Result – Remark	Verdict
A.2	Annex A2 Requirements for Type Testing of Synchronous Micro-generators		N/A

Appendix 1: Testing table

<p><b>Operating Range:</b> This test should be carried out as specified in EN 50438 D.3.1.</p> <p><b>Active Power</b> shall be recorded every second. The tests will verify that the <b>Micro-generator</b> can operate within the required ranges for the specified period of time.</p> <p>The <b>Interface Protection</b> shall be disabled during the tests.</p> <p>In case of a PV <b>Micro-generator</b> the PV primary source may be replaced by a <b>DC</b> source.</p> <p>In case of a full converter <b>Micro-generator</b> (eg wind) the primary source and the prime mover <b>Inverter/rectifier</b> may be replaced by a <b>DC</b> source.</p> <p>In case of a DFIG <b>Micro-generator</b> the mechanical drive system may be replaced by a test bench motor.</p>																					
<p>Test 1</p> <p>Voltage = 85% of nominal (195.5 V)</p> <p>Frequency = 47.5 Hz</p> <p>Power factor = 1</p> <p>Period of test 90 minutes</p>	<table border="1"> <caption>Test 1 Data Points (Estimated)</caption> <thead> <tr> <th>Time [s]</th> <th>Voltage (p.u.)</th> <th>Output power (p.u.)</th> <th>Frequency (Hz)</th> </tr> </thead> <tbody> <tr> <td>0</td> <td>0.85</td> <td>1.00</td> <td>47.5</td> </tr> <tr> <td>2000</td> <td>0.85</td> <td>0.99</td> <td>47.5</td> </tr> <tr> <td>4000</td> <td>0.85</td> <td>0.985</td> <td>47.5</td> </tr> <tr> <td>6000</td> <td>0.85</td> <td>0.98</td> <td>47.5</td> </tr> </tbody> </table>	Time [s]	Voltage (p.u.)	Output power (p.u.)	Frequency (Hz)	0	0.85	1.00	47.5	2000	0.85	0.99	47.5	4000	0.85	0.985	47.5	6000	0.85	0.98	47.5
Time [s]	Voltage (p.u.)	Output power (p.u.)	Frequency (Hz)																		
0	0.85	1.00	47.5																		
2000	0.85	0.99	47.5																		
4000	0.85	0.985	47.5																		
6000	0.85	0.98	47.5																		
<p>Test 2</p> <p>Voltage = 110% of nominal (253 V).</p> <p>Frequency = 51.5 Hz</p> <p>Power factor = 1</p> <p>Period of test 90 minutes</p>	<table border="1"> <caption>Test 2 Data Points (Estimated)</caption> <thead> <tr> <th>Time [s]</th> <th>Output power (p.u.)</th> <th>Voltage (p.u.)</th> <th>Frequency (Hz)</th> </tr> </thead> <tbody> <tr> <td>0</td> <td>1.00</td> <td>1.10</td> <td>51.5</td> </tr> <tr> <td>2000</td> <td>1.00</td> <td>1.10</td> <td>51.5</td> </tr> <tr> <td>4000</td> <td>1.00</td> <td>1.10</td> <td>51.5</td> </tr> <tr> <td>6000</td> <td>1.00</td> <td>1.10</td> <td>51.5</td> </tr> </tbody> </table>	Time [s]	Output power (p.u.)	Voltage (p.u.)	Frequency (Hz)	0	1.00	1.10	51.5	2000	1.00	1.10	51.5	4000	1.00	1.10	51.5	6000	1.00	1.10	51.5
Time [s]	Output power (p.u.)	Voltage (p.u.)	Frequency (Hz)																		
0	1.00	1.10	51.5																		
2000	1.00	1.10	51.5																		
4000	1.00	1.10	51.5																		
6000	1.00	1.10	51.5																		

Appendix 1: Testing table

<p>Test 3</p> <p>Voltage = 110% of nominal (253 V).</p> <p>Frequency = 52.0 Hz</p> <p>Power factor = 1</p> <p>Period of test 15 minutes</p>	<table border="1"><caption>Graph Data</caption><thead><tr><th>Time [s]</th><th>Voltage (p.u)</th><th>Output power (p.u)</th><th>Frequency (Hz)</th></tr></thead><tbody><tr><td>0</td><td>1.10</td><td>1.00</td><td>52.00</td></tr><tr><td>500</td><td>1.10</td><td>1.00</td><td>52.00</td></tr><tr><td>1000</td><td>1.10</td><td>1.00</td><td>52.00</td></tr><tr><td>1500</td><td>1.10</td><td>1.00</td><td>52.00</td></tr></tbody></table>	Time [s]	Voltage (p.u)	Output power (p.u)	Frequency (Hz)	0	1.10	1.00	52.00	500	1.10	1.00	52.00	1000	1.10	1.00	52.00	1500	1.10	1.00	52.00
Time [s]	Voltage (p.u)	Output power (p.u)	Frequency (Hz)																		
0	1.10	1.00	52.00																		
500	1.10	1.00	52.00																		
1000	1.10	1.00	52.00																		
1500	1.10	1.00	52.00																		

Appendix 1: Testing table

Power Quality – Harmonics: These tests should be carried out as specified in BS EN 61000-3-2. The chosen test should be undertaken with a fixed source of energy at two power levels a) between 45 and 55% and b) at 100% of Registered Capacity. The test requirements are specified in Annex A1 A.1.3.1 (Inverter connected) or Annex A2 A.2.3.1 (Synchronous).						
Micro-generator tested to BS EN 61000-3-2						
<b>Micro-generator</b> rating per phase (rpp)			3.0	kW		
Harmonic	At 45-55% of <b>Registered Capacity</b>		100% of <b>Registered Capacity</b>			
	Measured Value MV in Amps		Measured Value MV in Amps		Limit in BS EN 61000-3-2 in Amps	Higher limit for odd harmonics 21 and above
2	0.0143		0.0219		1.080	
3	0.0835		0.1033		2.300	
4	0.0112		0.0093		0.430	
5	0.0323		0.0356		1.140	
6	0.0143		0.0137		0.300	
7	0.0108		0.0279		0.770	
8	0.0176		0.0134		0.230	
9	0.0206		0.0350		0.400	
10	0.0130		0.0125		0.184	
11	0.0215		0.0416		0.330	
12	0.0125		0.0099		0.153	
13	0.0235		0.0429		0.210	
14	0.0100		0.0099		0.131	
15	0.0252		0.0425		0.150	
16	0.0087		0.0066		0.115	
17	0.0248		0.0397		0.132	
18	0.0088		0.0088		0.102	

Appendix 1: Testing table

19	0.0234		0.0363		0.118	
20	0.0091		0.0087		0.092	
21	0.0201		0.0324		0.107	0.160
22	0.0076		0.0072		0.084	
23	0.0175		0.0294		0.098	0.147
24	0.0101		0.0088		0.077	
25	0.0166		0.0254		0.090	0.135
26	0.0105		0.0081		0.071	
27	0.0151		0.0223		0.083	0.124
28	0.0051		0.0110		0.066	
29	0.0131		0.0203		0.078	0.117
30	0.0012		0.0044		0.061	
31	0.0113		0.0185		0.073	0.109
32	0.0015		0.0028		0.058	
33	0.0102		0.0156		0.068	0.102
34	0.0025		0.0043		0.054	
35	0.0095		0.0134		0.064	0.096
36	0.0036		0.0040		0.051	
37	0.0080		0.0110		0.061	0.091
38	0.0023		0.0041		0.048	
39	0.0087		0.0108		0.058	0.087
40	0.0022		0.0036		0.046	

Note the higher limits for odd harmonics 21 and above are only allowable under certain conditions, if these higher limits are utilised please state the exemption used as detailed in part 6.2.3.4 of BS EN 61000-3-2 in the box below.



Appendix 1: Testing table

<b>Power Quality – Voltage fluctuations and Flicker:</b> These tests should be undertaken in accordance with EREC G98 Annex A1 A.1.3.3 ( <b>Inverter</b> connected) or Annex A2 A.2.3.3 (Synchronous).								
	Starting			Stopping			Running	
	d max	d c	d(t)	d max	d c	d(t)	P <sub>st</sub>	P <sub>it</sub> 2 hours
Measured Values at test impedance	--	--	--	--	--	--	--	--
Normalised to standard impedance	0.176	0.039	0.00	0.176	0.039	0.00	0.041	0.029
Normalised to required maximum impedance	--	--	--	--	--	--	--	--
Limits set under BS EN 61000-3-11	4%	3.3%	3.3%	4%	3.3%	3.3%	1.0	0.65
Test Impedance	R		Ω	X			Ω	
Standard Impedance	R	0.24 * 0.4 ^	Ω	X		0.15 * 0.25 ^	Ω	
Maximum Impedance	R		Ω	X			Ω	
<p>Applies to three phase and split single phase <b>Micro-generators</b>.</p> <p>^ Applies to single phase <b>Micro-generators</b> and <b>Micro-generators</b> using two phases on a three phase system.</p> <p>For voltage change and flicker measurements the following formula is to be used to convert the measured values to the normalised values where the power factor of the generation output is 0.98 or above.</p> <p>Normalised value = Measured value*reference source resistance/measured source resistance at test point.</p> <p>Single phase units reference source resistance is 0.4 Ω</p>								

Appendix 1: Testing table

<p>Two phase units in a three phase system reference source resistance is 0.4 <math>\Omega</math>.</p> <p>Two phase units in a split phase system reference source resistance is 0.24 <math>\Omega</math>.</p> <p>Three phase units reference source resistance is 0.24 <math>\Omega</math>.</p> <p>Where the power factor of the output is under 0.98 then the X to R ratio of the test impedance should be close to that of the Standard Impedance.</p> <p>The stopping test should be a trip from full load operation.</p> <p>The duration of these tests need to conform to the particular requirements set out in the testing notes for the technology under test. Dates and location of the test need to be noted below.</p>			
Test start date	23 Feb 2019	Test end date	23 Feb 2019
Test location	Block E, No.7-2 Guang Dong Software Science Park, Caipin Road, Guangzhou Science City, GETDD, Guangzhou, China		

Appendix 1: Testing table

<b>Power quality – DC injection:</b> This test should be carried out in accordance with EN 50438 Annex D.3.10				
Test power level	20%	50%	75%	100%
Recorded value in Amps	0.0225	0.0258	0.0231	0.0186
as % of rated AC current	0.1731%	0.1985%	0.1777%	0.1431%
Limit	0.25%	0.25%	0.25%	0.25%

Appendix 1: Testing table

<b>Power Quality – Power factor:</b> This test shall be carried out in accordance with EN 50538 Annex D.3.4.1 but with nominal voltage -6% and +10%. Voltage to be maintained within $\pm 1.5\%$ of the stated level during the test.			
	216.2 V	230 V	253 V
20% of <b>Registered Capacity</b>	0.9820	0.9781	0.9714
50% of <b>Registered Capacity</b>	0.9966	0.9958	0.9943
75% of <b>Registered Capacity</b>	0.9981	0.9977	0.9971
100% of <b>Registered Capacity</b>	0.9986	0.9984	0.9981
Limit	>0.95	>0.95	>0.95

Appendix 1: Testing table

**Protection – Frequency tests:** These tests should be carried out in accordance with EN 50438 Annex D.2.4 and the notes in EREC G98 Annex A1 A.1.2.3 (**Inverter** connected) or Annex A2 A.2.2.3 (Synchronous)

Function	Setting		Trip test		“No trip tests”	
	Frequency	Time delay	Frequency	Time delay	Frequency /time	Confirm no trip
U/F stage 1	47.5 Hz	20 s	47.48Hz	20.05s	47.7 Hz 30 s	No trip
U/F stage 2	47 Hz	0.5 s	46.96Hz	0.522s	47.2 Hz 19.5 s	20.1s trip
					46.8 Hz 0.45 s	0.524s trip
O/F stage 1	52 Hz	0.5 s	52.01Hz	0.510s	51.8 Hz 120.0s	No trip
					52.2 Hz 0.45 s	0.532s trip

Note. For frequency trip tests the frequency required to trip is the setting  $\pm 0.1$  Hz. In order to measure the time delay a larger deviation than the minimum required to operate the projection can be used. The “No trip tests” need to be carried out at the setting  $\pm 0.2$  Hz and for the relevant times as shown in the table above to ensure that the protection will not trip in error.

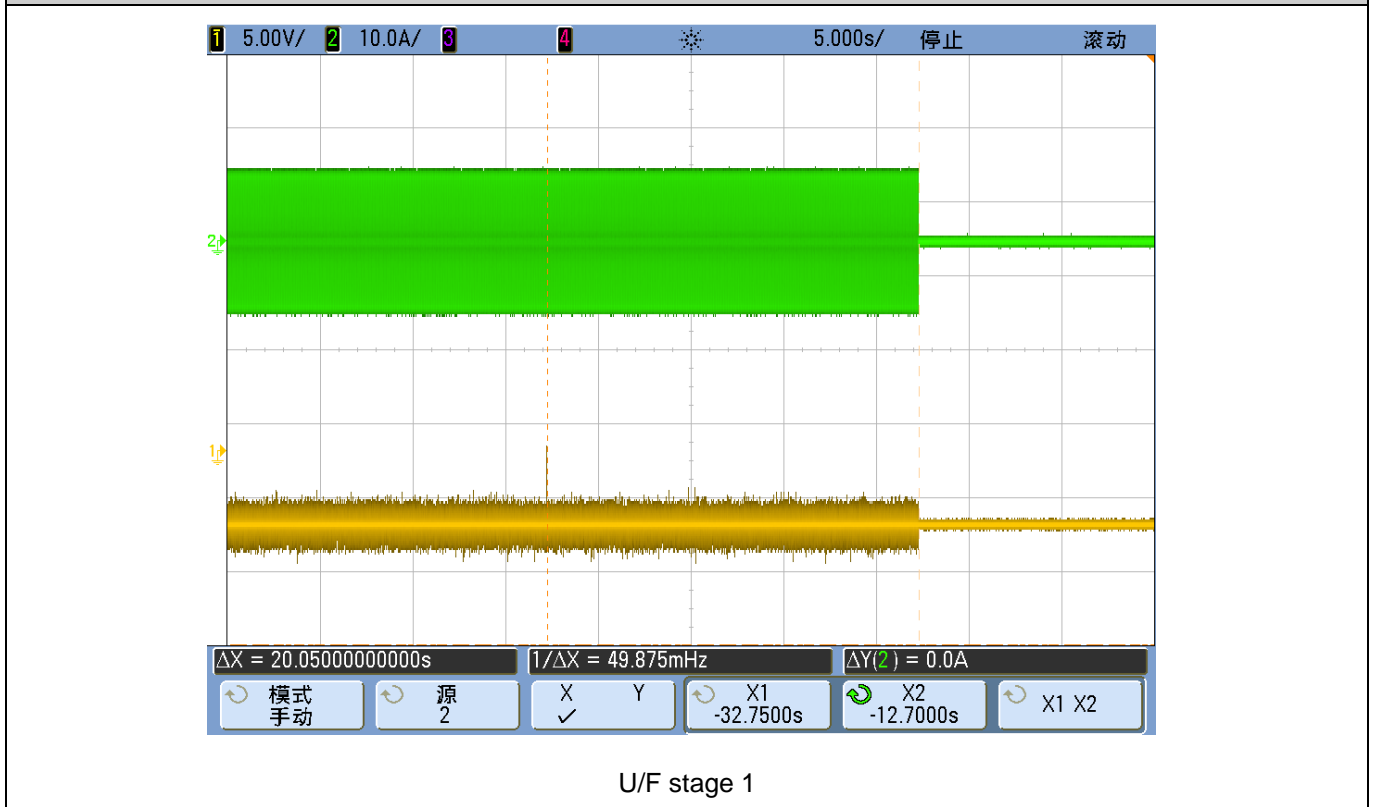

Appendix 1: Testing table

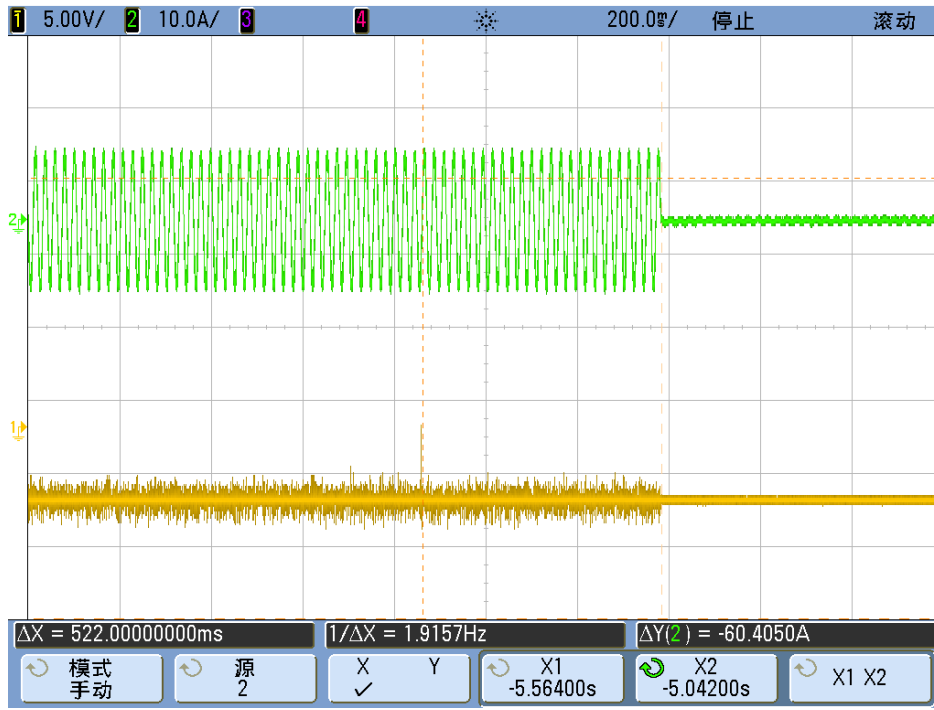

U/F stage 2

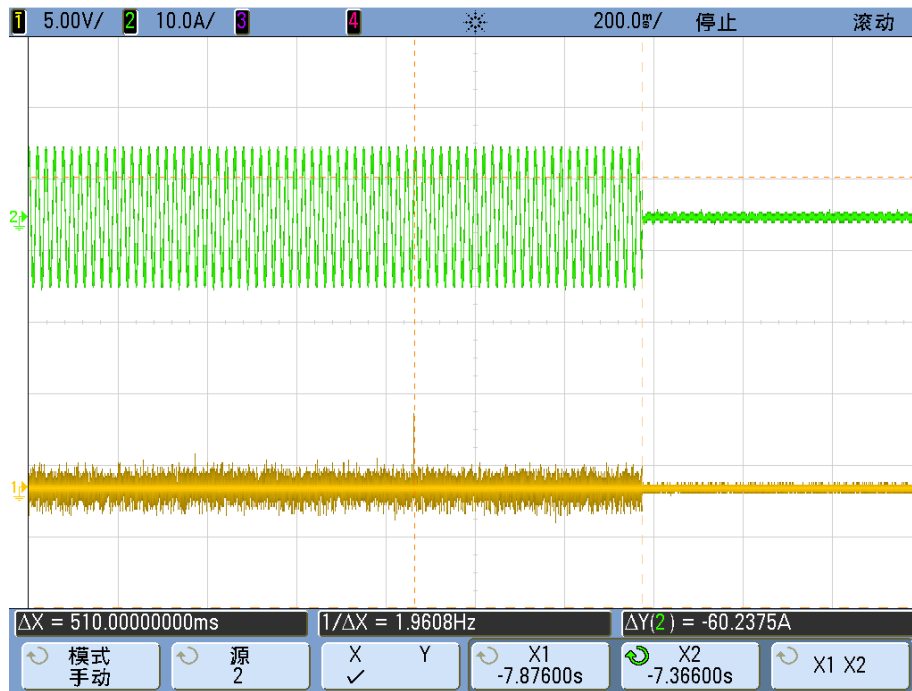

O/F stage 1

CH2: Current of EUT; CH1: trip signal

Appendix 1: Testing table

<b>Protection – Voltage tests:</b> These tests should be carried out in accordance with EN 50438 Annex D.2.3 and the notes in EREC G98 Annex A1 A.1.2.2 ( <b>Inverter</b> connected) or Annex A2 A.2.2.2 (Synchronous)						
Function	Setting		Trip test		“No trip tests”	
	Voltage	Time delay	Voltage	Time delay	Voltage /time	Confirm no trip
U/V	184 V	2.5 s	183.37V	2.53s	188 V 5.00 s	No trip
					180 V 2.45 s	2.537s trip
O/V stage 1	262.2 V	1.0 s	261.9V	1.01s	258.2 V 5.0 s	No trip
					269.7 V 0.95 s	1.05s trip
O/V stage 2	273.7 V	0.5 s	273.3V	0.515s	277.7 V 0.45 s	0.517s trip

Note for Voltage tests the Voltage required to trip is the setting  $\pm 3.45$  V. The time delay can be measured at a larger deviation than the minimum required to operate the protection. The No trip tests need to be carried out at the setting  $\pm 4$  V and for the relevant times as shown in the table above to ensure that the protection will not trip in error.

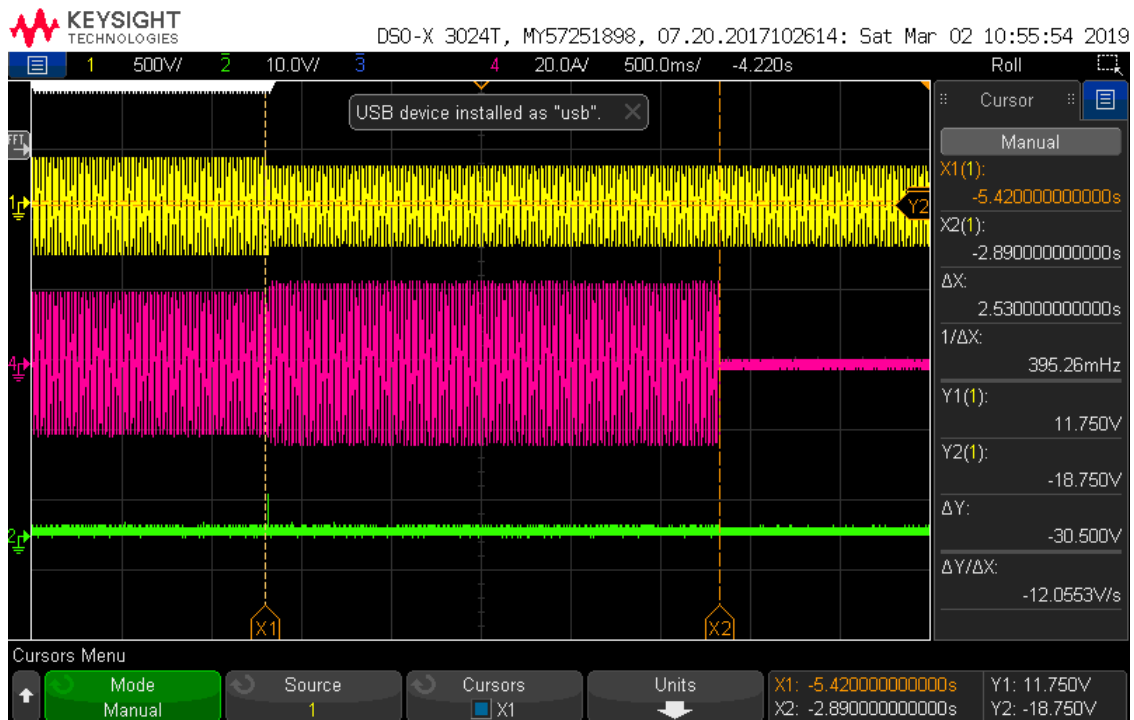

U/V

CH1: Voltage of EUT; CH4: Current of EUT; CH2: trip signal

Appendix 1: Testing table

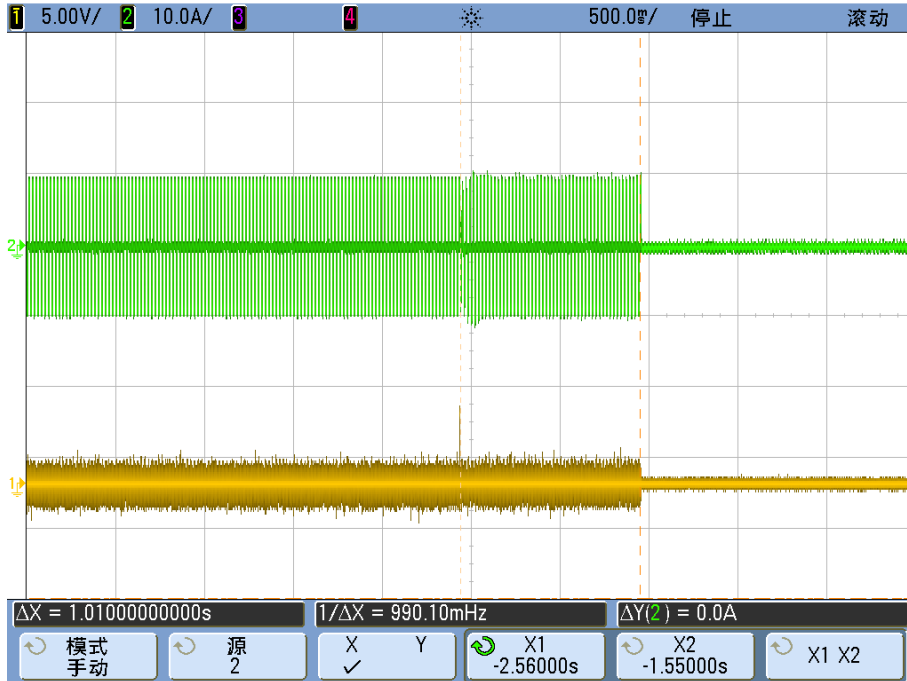

O/V stage 1

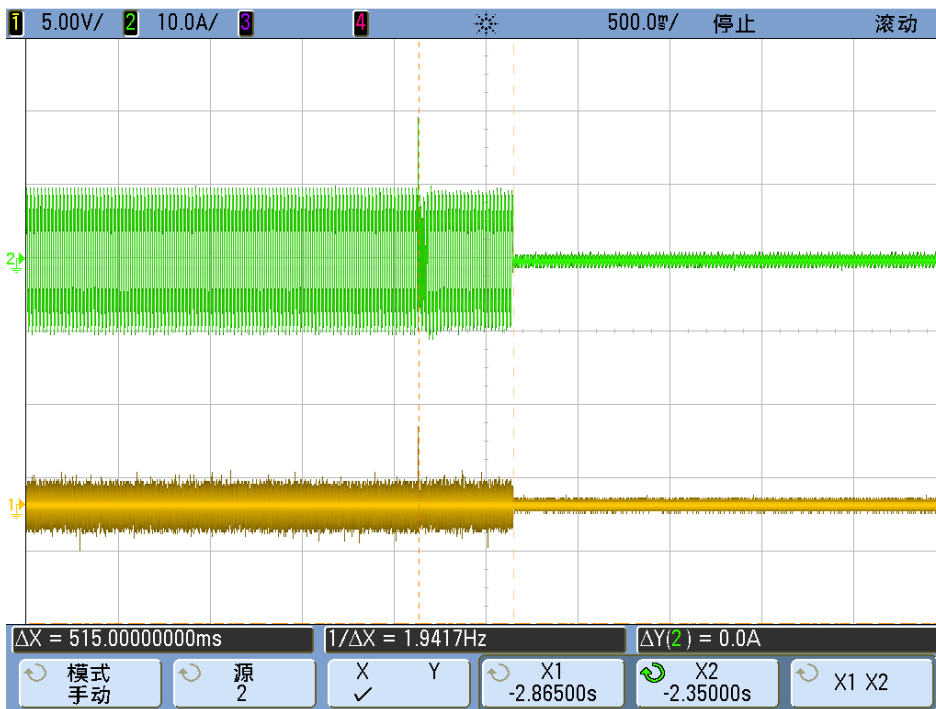

O/V stage 2

CH2: Current of EUT; CH1: trip signal



Appendix 1: Testing table

Protection – Loss of Mains test: For PV Inverters shall be tested in accordance with BS EN 62116. Other Inverters should be tested in accordance with EN 50438 Annex D.2.5 at 10%, 55% and 100% of rated power.						
To be carried out at three output power levels with a tolerance of plus or minus 5% in Test Power levels.						
Test Power	10%	55%	100%	10%	55%	100%
Balancing load on islanded network	95% of <b>Registered Capacity</b>	95% of <b>Registered Capacity</b>	95% of <b>Registered Capacity</b>	105% of <b>Registered Capacity</b>	105% of <b>Registered Capacity</b>	105% of <b>Registered Capacity</b>
Trip time. Limit is 0.5 s	--	--	--	--	--	--
For Multi phase <b>Micro-generators</b> confirm that the device shuts down correctly after the removal of a single fuse as well as operation of all phases.						
Test Power	10%	55%	100%	10%	55%	100%
Balancing load on islanded network	95% of <b>Registered Capacity</b>	95% of <b>Registered Capacity</b>	95% of <b>Registered Capacity</b>	105% of <b>Registered Capacity</b>	105% of <b>Registered Capacity</b>	105% of <b>Registered Capacity</b>
Trip time. Ph1 fuse removed	--	--	--	--	--	--
Test Power	10%	55%	100%	10%	55%	100%
Balancing load on islanded network	95% of <b>Registered Capacity</b>	95% of <b>Registered Capacity</b>	95% of <b>Registered Capacity</b>	105% of <b>Registered Capacity</b>	105% of <b>Registered Capacity</b>	105% of <b>Registered Capacity</b>
Trip time. Ph2 fuse removed	--	--	--	--	--	--
Test Power	10%	55%	100%	10%	55%	100%
Balancing load on islanded network	95% of <b>Registered Capacity</b>	95% of <b>Registered Capacity</b>	95% of <b>Registered Capacity</b>	105% of <b>Registered Capacity</b>	105% of <b>Registered Capacity</b>	105% of <b>Registered Capacity</b>
Trip time. Ph3 fuse removed	--	--	--	--	--	--
Note for technologies which have a substantial shut down time this can be added to the 0.5 s in establishing that the trip occurred in less than 0.5 s. Maximum shut down time could therefore be up to 1.0 s for these technologies.						
Indicate additional shut down time included in above results					ms	

Appendix 1: Testing table

For <b>Inverters</b> tested to BS EN 62116 the following sub set of tests should be recorded in the following table.						
Test Power and imbalance	33% -5% Q Test 22	66% -5% Q Test 12	100% -5% P Test 5	33% +5% Q Test 31	66% +5% Q Test 21	100% +5% P Test 10
Trip time. Limit is 0.5 s	201.5ms	209.0ms	288.0ms	263.0ms	288.0ms	287.0ms

Appendix 1: Testing table

<b>Protection – Frequency change, Vector Shift Stability test:</b> This test should be carried out in accordance with EREC G98 Annex A1 A.1.2.6 (Inverter connected) or Annex A2 A.2.2.6 (Synchronous).			
	Start Frequency	Change	Confirm no trip
Positive Vector Shift	49.0 Hz	+50 degrees	No trip
Negative Vector Shift	50.0 Hz	- 50 degrees	No trip

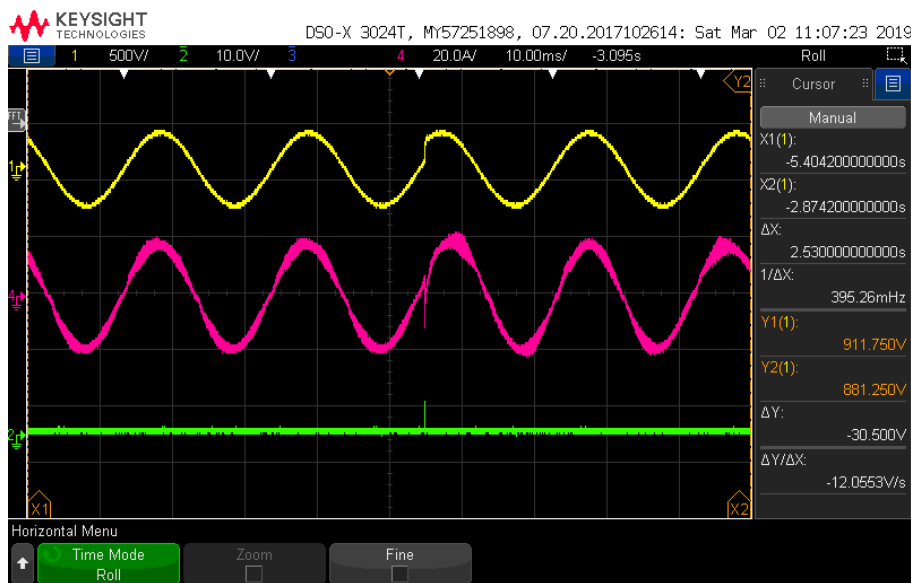

Positive Vector Shift

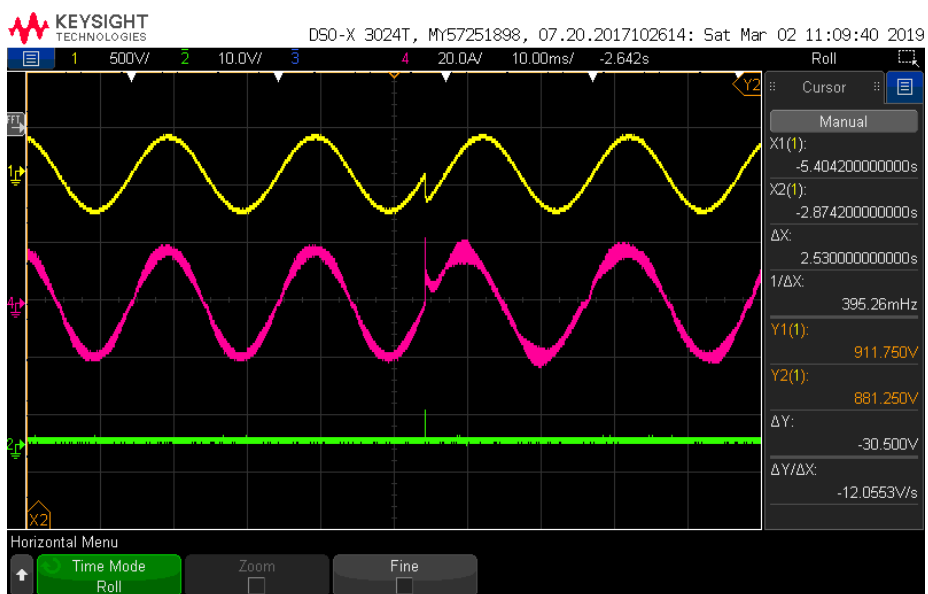

Negative Vector Shift

Appendix 1: Testing table

<b>Protection – Frequency change, RoCoF Stability test:</b> The requirement is specified in section 11.3, test procedure in Annex A.1.2.6 (Inverter connected) or Annex A2 A.2.2.6 (Synchronous).			
Ramp range	Test frequency ramp:	Test Duration	Confirm no trip
49.0 Hz to 51.0 Hz	+0.95 Hzs <sup>-1</sup>	2.1 s	No trip
51.0 Hz to 49.0 Hz	-0.95 Hzs <sup>-1</sup>	2.1 s	No trip

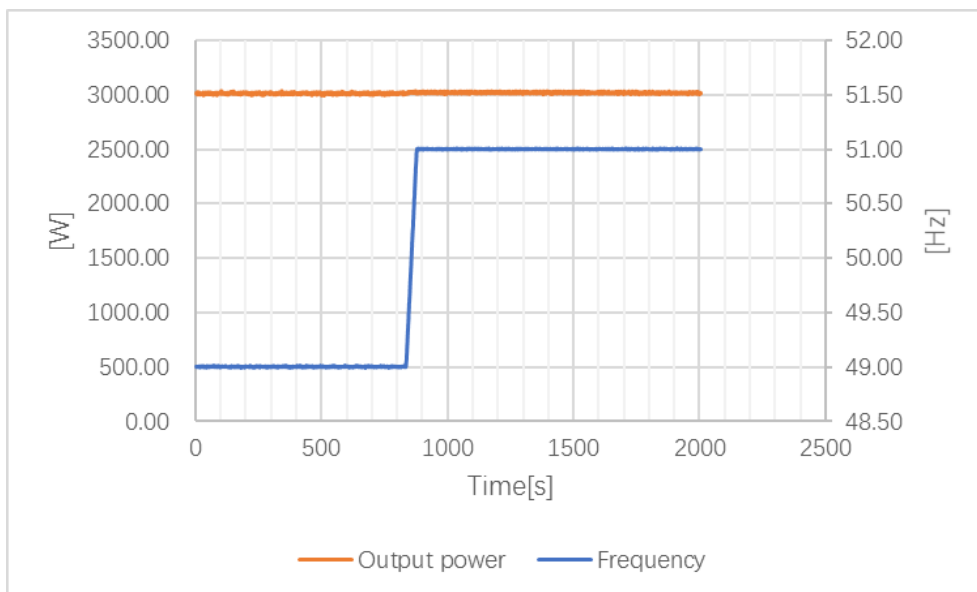

49.0 Hz to 51.0 Hz

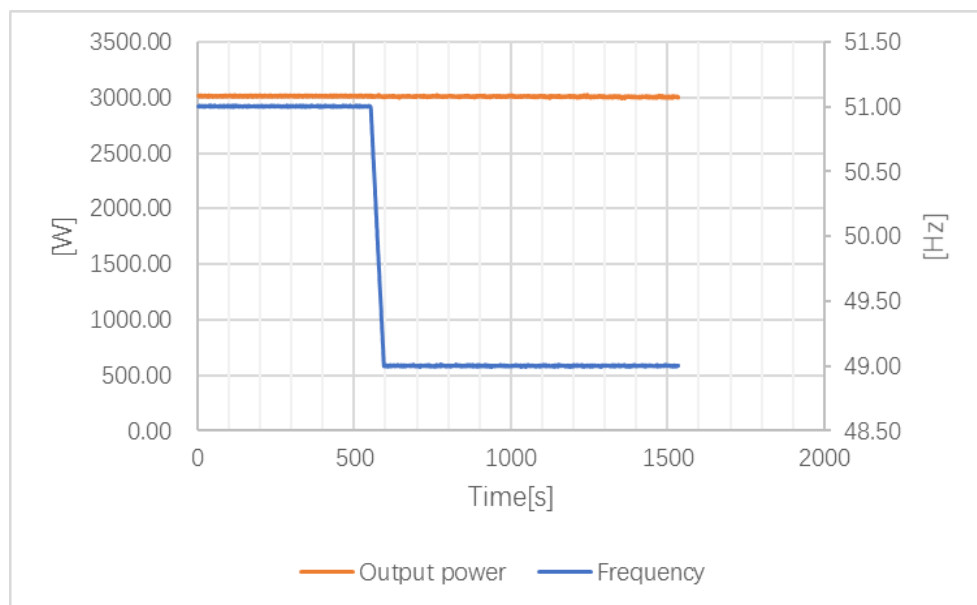

51.0 Hz to 49.0 Hz

Appendix 1: Testing table

<b>Limited Frequency Sensitive Mode – Overfrequency test:</b> This test should be carried out in accordance with EN 50438 Annex D.3.3 Power response to over- frequency. The test should be carried out using the specific threshold frequency of 50.4 Hz and <b>Droop</b> of 10%.				
Test sequence at <b>Registered Capacity &gt;80%</b>	Measured <b>Active Power</b> Output	Frequency	Primary Power Source	<b>Active Power</b> Gradient Droop(%)
Step a) 50.00 Hz ±0.01 Hz	3021.48W	50.00Hz	3126.53W	N/A
Step b) 50.45 Hz ±0.05 Hz	2991.06W	50.45Hz		9.92
Step c) 50.70 Hz ±0.10 Hz	2841.35W	50.70Hz		10.06
Step d) 51.15 Hz ±0.05 Hz	2594.53W	51.15Hz		10.61
Step e) 50.70 Hz ±0.10 Hz	2846.98W	50.70Hz		10.39
Step f) 50.45 Hz ±0.05 Hz	2991.00W	50.45Hz		9.90
Step g) 50.00 Hz ±0.01 Hz	3021.55W	50.00Hz		N/A
Test sequence at <b>Registered Capacity 40% - 60%</b>	Measured <b>Active Power</b> Output	Frequency	Primary Power Source	<b>Active Power</b> Gradient Droop(%)
Step a) 50.00 Hz ±0.01 Hz	1513.84W	50.00Hz	1567.48W	N/A
Step b) 50.45 Hz ±0.05 Hz	1498.71W	50.45Hz		9.91
Step c) 50.70 Hz ±0.10 Hz	1423.34W	50.70Hz		10.02
Step d) 51.15 Hz ±0.05 Hz	1294.62W	51.15Hz		10.35
Step e) 50.70 Hz ±0.10 Hz	1425.97W	50.70Hz		10.32
Step f) 50.45 Hz ±0.05 Hz	1498.66W	50.45Hz		9.88
Step g) 50.00 Hz ±0.01 Hz	1514.12W	50.00Hz		N/A

Appendix 1: Testing table

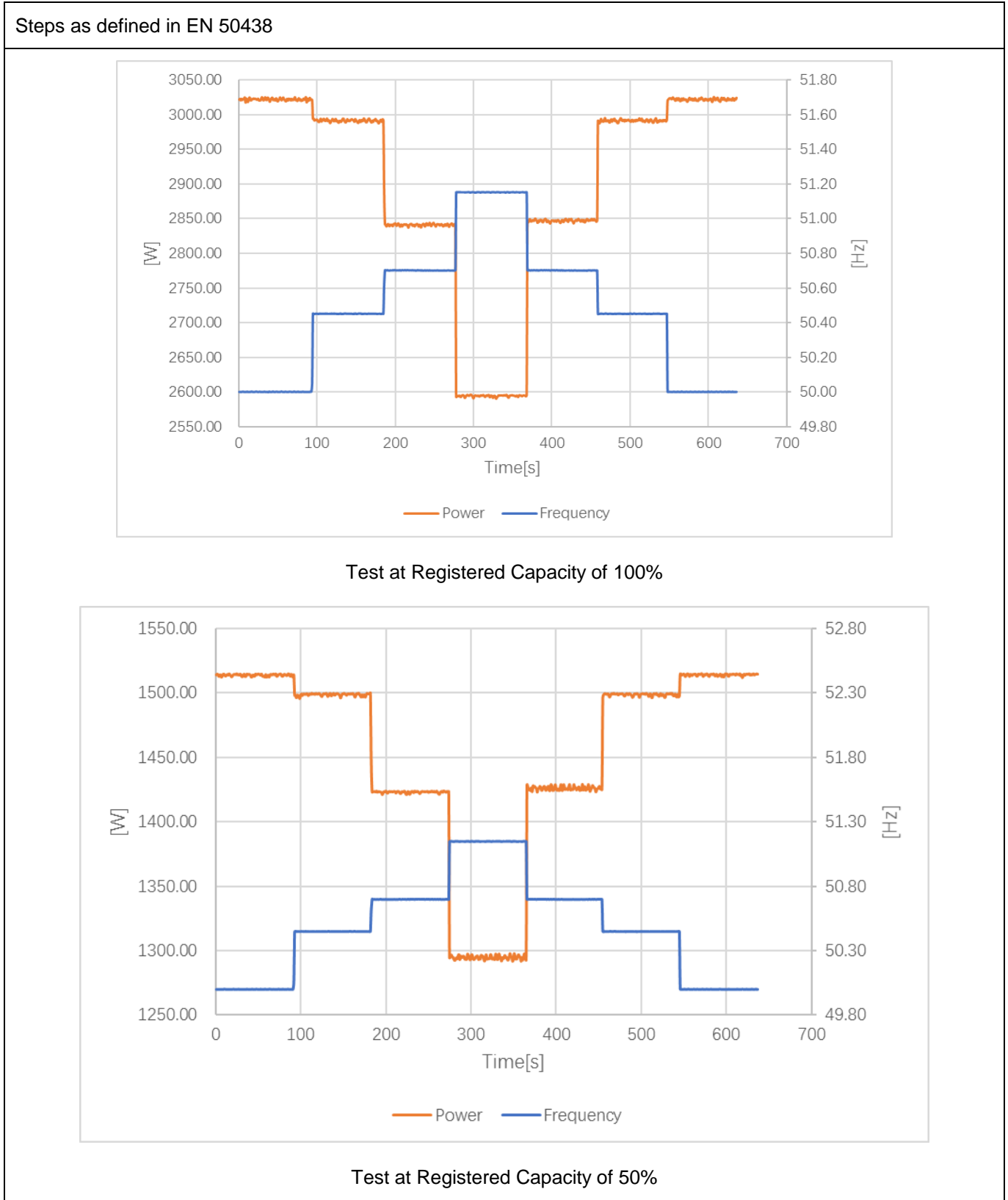

Appendix 1: Testing table

<b>Power output with falling frequency test:</b> This test should be carried out in accordance with EN 50438 Annex D.3.2 active power feed-in at under-frequency.			
Test sequence	Measured <b>Active Power</b> Output	Frequency	Primary power source
Test a) 50 Hz $\pm$ 0.01 Hz	3036.26W	50.00Hz	3281.28W
Test b) Point between 49.5 Hz and 49.6 Hz	3038.11W	49.55Hz	3286.85W
Test c) Point between 47.5 Hz and 47.6 Hz	3042.95W	47.55Hz	3294.60W

NOTE: The operating point in Test (b) and (c) shall be maintained for at least 5 minutes

The graph displays two data series over a 1000-second period. The Power series (orange line) is constant at 3000.00 W. The Frequency series (blue line) starts at 50.00 Hz, drops to 49.50 Hz at 300s, and then drops to 47.50 Hz at 650s. The x-axis is Time [s] from 0 to 1200. The left y-axis is Power [W] from 0.00 to 3500.00. The right y-axis is Frequency [Hz] from 47.00 to 50.50.

Appendix 1: Testing table

Re-connection timer.						
Test should prove that the reconnection sequence starts after a minimum delay of 20 s for restoration of voltage and frequency to within the stage 1 settings of Table 2.						
Time delay setting	Measured delay		Checks on no reconnection when voltage or frequency is brought to just outside stage 1 limits of table 2.			
60s	70.2s		At 266.2 V	At 180.0 V	At 47.4 Hz	At 52.1 Hz
Confirmation that the <b>Micro-generator</b> does not re-connect.			Not reconnection	Not reconnection	Not reconnection	Not reconnection

Fault level contribution: These tests shall be carried out in accordance with EREC G98 Annex A1 A.1.3.5 ( <b>Inverter</b> connected) and Annex A2 A.2.3.4 (Synchronous).					
For machines with electro-magnetic output			For <b>Inverter</b> output		
Parameter	Symbol	Value	Time after fault	Volts	Amps
Peak Short Circuit current	$i_p$	--	20 ms	30V	11.95A
Initial Value of aperiodic current	$A$	--	100 ms	42V	11.95A
Initial symmetrical short-circuit current*	$I_k$	--	250 ms	--	--
Decaying (aperiodic) component of short circuit current*	$i_{DC}$	--	500 ms	--	--
Reactance/Resistance Ratio of source*	$X/R$	2.5	Time to trip	0.218	In seconds
For rotating machines and linear piston machines the test should produce a 0 s – 2 s plot of the short circuit current as seen at the <b>Micro-generator</b> terminals.					
* Values for these parameters should be provided where the short circuit duration is sufficiently long to enable interpolation of the plot					



Appendix 1: Testing table

<b>Logic Interface.</b>	Yes
<b>Self-Monitoring solid state switching:</b> No specified test requirements. Refer to EREC G98 Annex A1 A.1.3.6 ( <b>Inverter</b> connected).	N/A
It has been verified that in the event of the solid state switching device failing to disconnect the <b>Micro-generator</b> , the voltage on the output side of the switching device is reduced to a value below 50 V within 0.5 s.	N/A
<b>Additional comments</b>	

Appendix 1: Testing table

<b>Protection.Loss of Mains (LoM) detection</b> <b>The requirement is specified in section 5.3.2, test procedure in Annex A</b> <b>as an alternative, inverters can be tested to BS EN 62116.</b> <b>Model: HYD 3600-ES</b>									P
No.	PEUT <sup>1)</sup> (% of EUT rating)	Reactive load (% of QL in 6.1.d)1)	PAC <sup>2)</sup> (% of nominal)	QAC <sup>3)</sup> (% of nominal)	Run on time (ms)	PEUT (KW)	Actual Qf	VDC	Remarks <sup>4)</sup>
1	100	100	0	0	386.0	3000	1.01	50	Test A at BL
2	66	66	0	0	429.0	1980	1.02	50	Test B at BL
3	33	33	0	0	312.0	990	1.03	50	Test C at BL
4	100	100	-5	-5	312.5	3000	0.98	50	Test A at IB
5	100	100	-5	0	250.5	3000	0.98	50	Test A at IB
6	100	100	-5	5	263.0	3000	1.01	50	Test A at IB
7	100	100	0	-5	298.0	3000	1.00	50	Test A at IB
8	100	100	0	5	287.0	3000	1.02	50	Test A at IB
9	100	100	5	-5	280.0	3000	1.05	50	Test A at IB
10	100	100	5	0	298.5	3000	1.02	50	Test A at IB
11	100	100	5	5	336.0	3000	0.95	50	Test A at IB
12	66	66	0	-5	209.0	1980	0.99	50	Test B at IB
13	66	66	0	-4	237.0	1980	0.97	50	Test B at IB
14	66	66	0	-3	311.0	1980	0.98	50	Test B at IB
15	66	66	0	-2	325.0	1980	1.02	50	Test B at IB
16	66	66	0	-1	282.5	1980	1.03	50	Test B at IB
17	66	66	0	1	285.5	1980	0.99	50	Test B at IB
18	66	66	0	2	228.5	1980	1.02	50	Test B at IB
19	66	66	0	3	248.5	1980	1.03	50	Test B at IB
20	66	66	0	4	292.0	1980	1.03	50	Test B at IB
21	66	66	0	5	288.0	1980	1.04	50	Test B at IB
22	33	33	0	-5	201.5	990	0.95	50	Test C at IB
23	33	33	0	-4	247.0	990	0.99	50	Test C at IB
24	33	33	0	-3	220.5	990	0.97	50	Test C at IB
25	33	33	0	-2	235.0	990	0.98	50	Test C at IB
26	33	33	0	-1	334.0	990	1.01	50	Test C at IB
27	33	33	0	1	324.5	990	0.99	50	Test C at IB
28	33	33	0	2	326.0	990	1.00	50	Test C at IB
29	33	33	0	3	333.0	990	0.99	50	Test C at IB
30	33	33	0	4	286.5	990	1.01	50	Test C at IB
31	33	33	0	5	263.0	990	1.01	50	Test C at IB

Appendix 2: photos



Overview

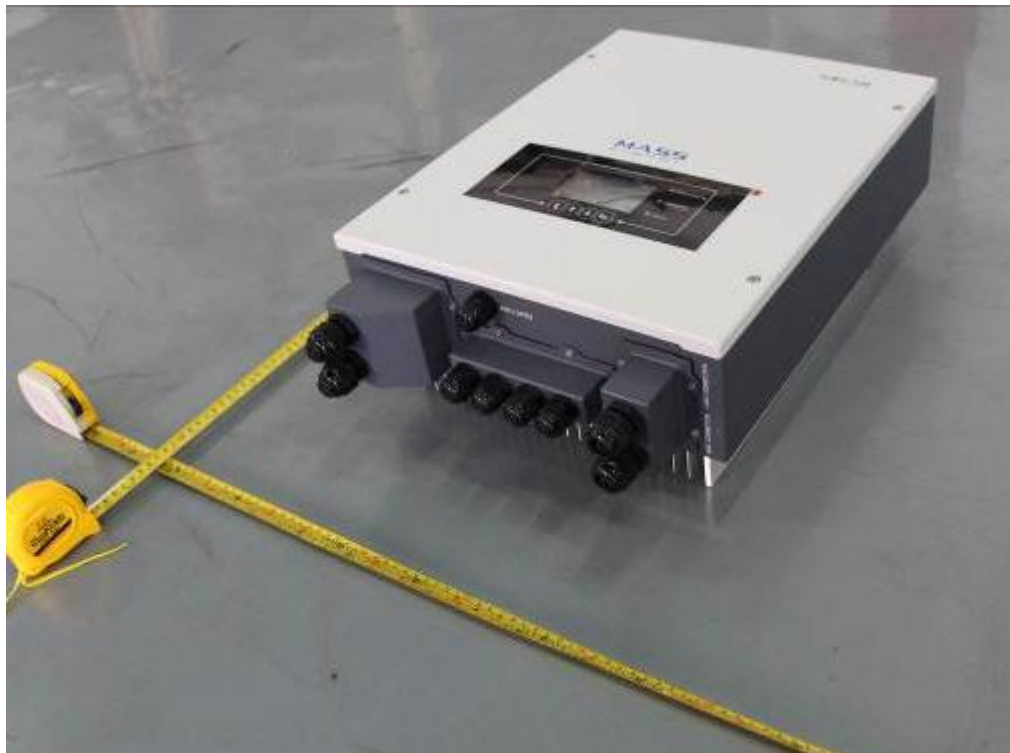

Overview

Appendix 2: photos



Top view



Heatsink view

Appendix 2: photos

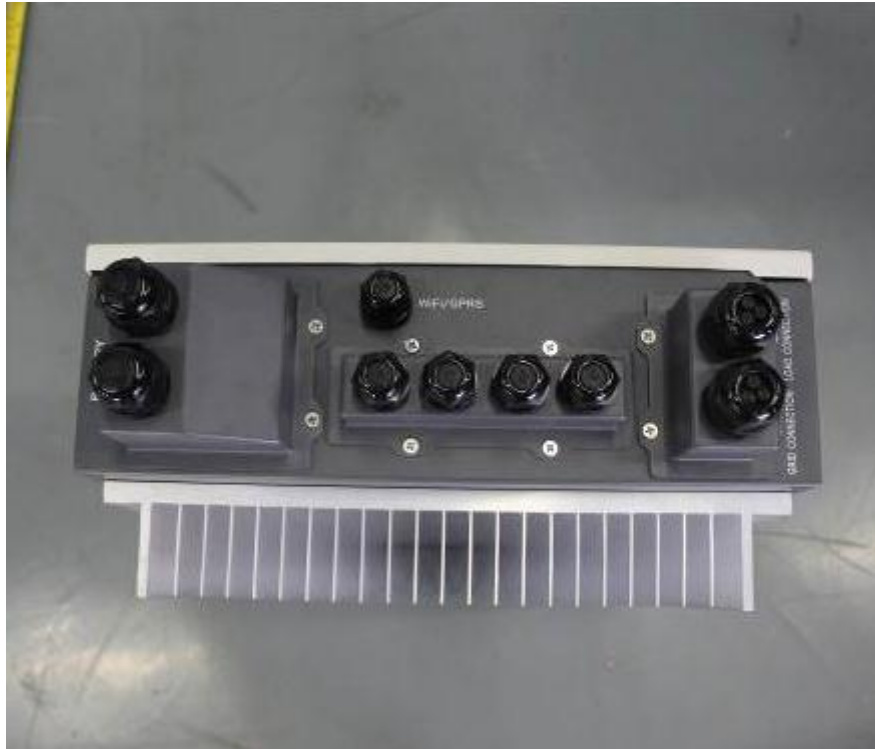

Terminal view



Terminal view

Appendix 2: photos



Inside view



Inside view

Appendix 2: Photos

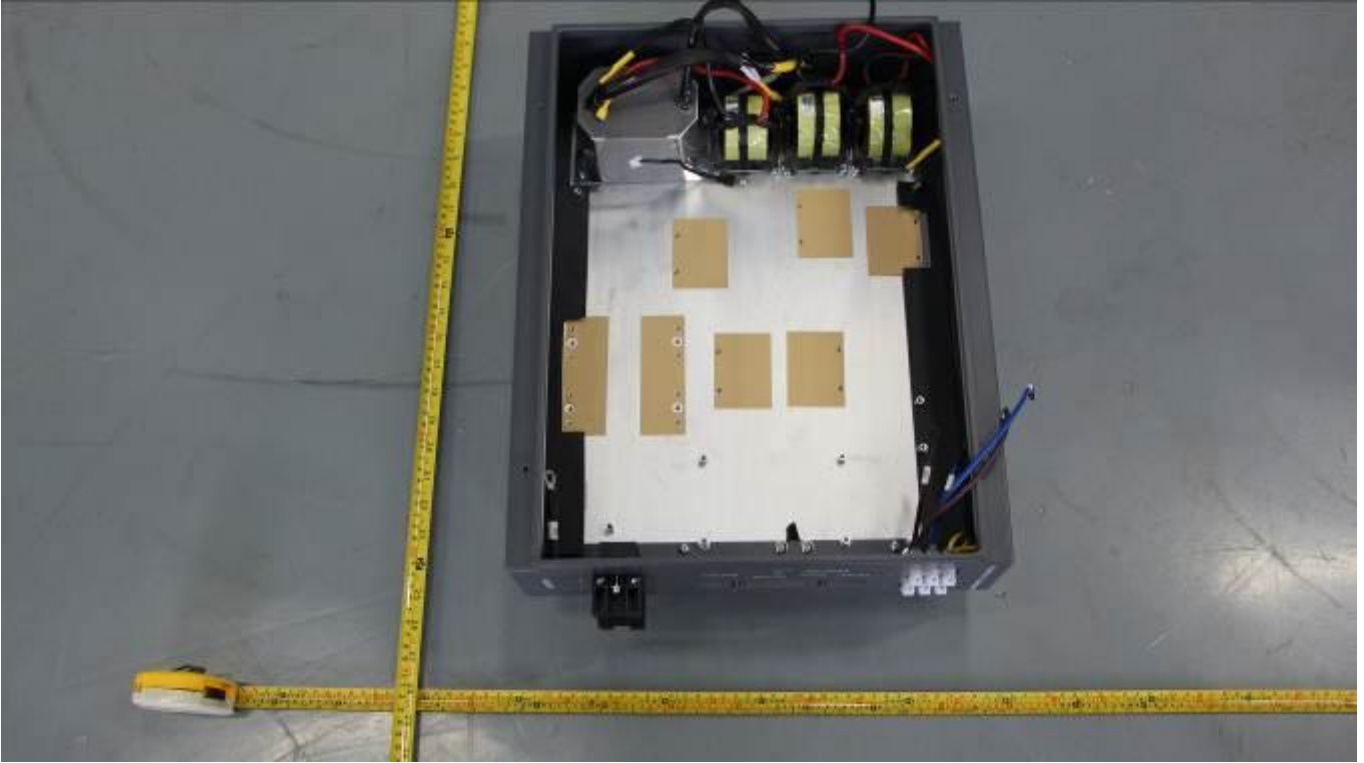

Inside view



Communication board view

Appendix 2: Photos

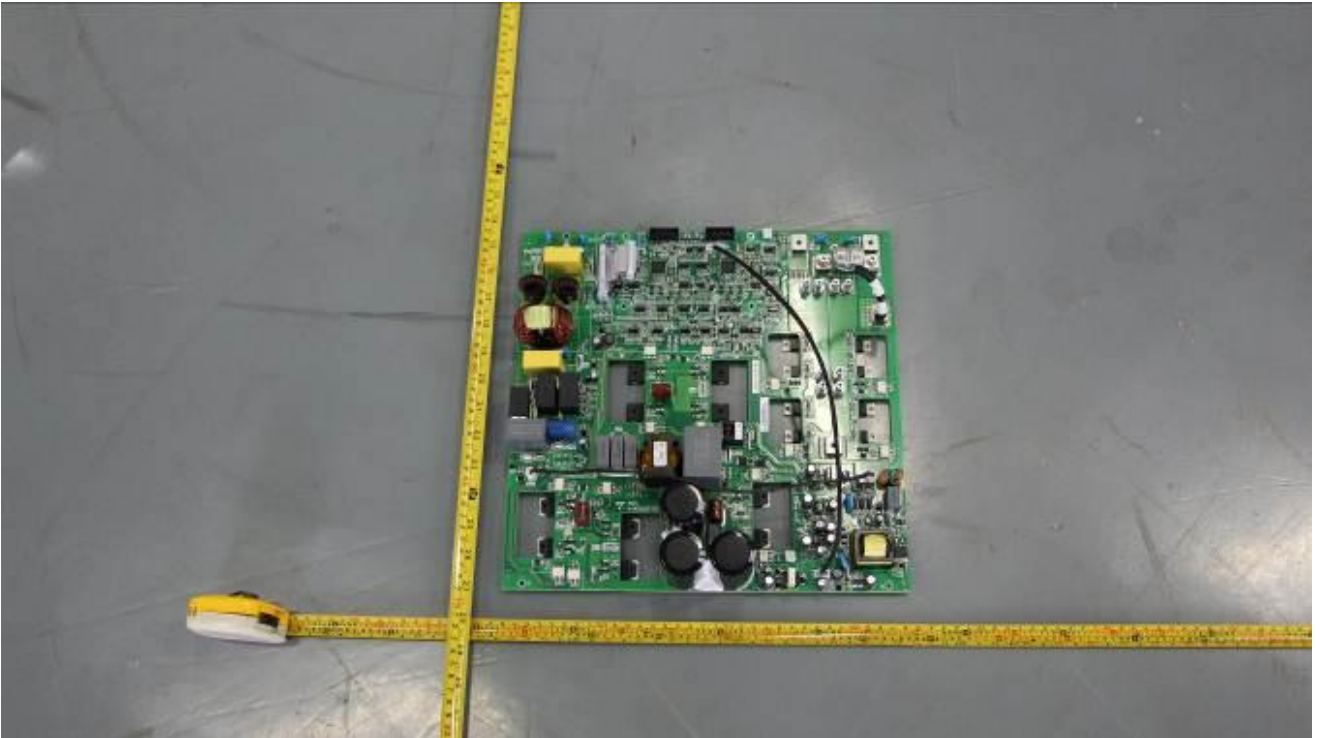

Main board view

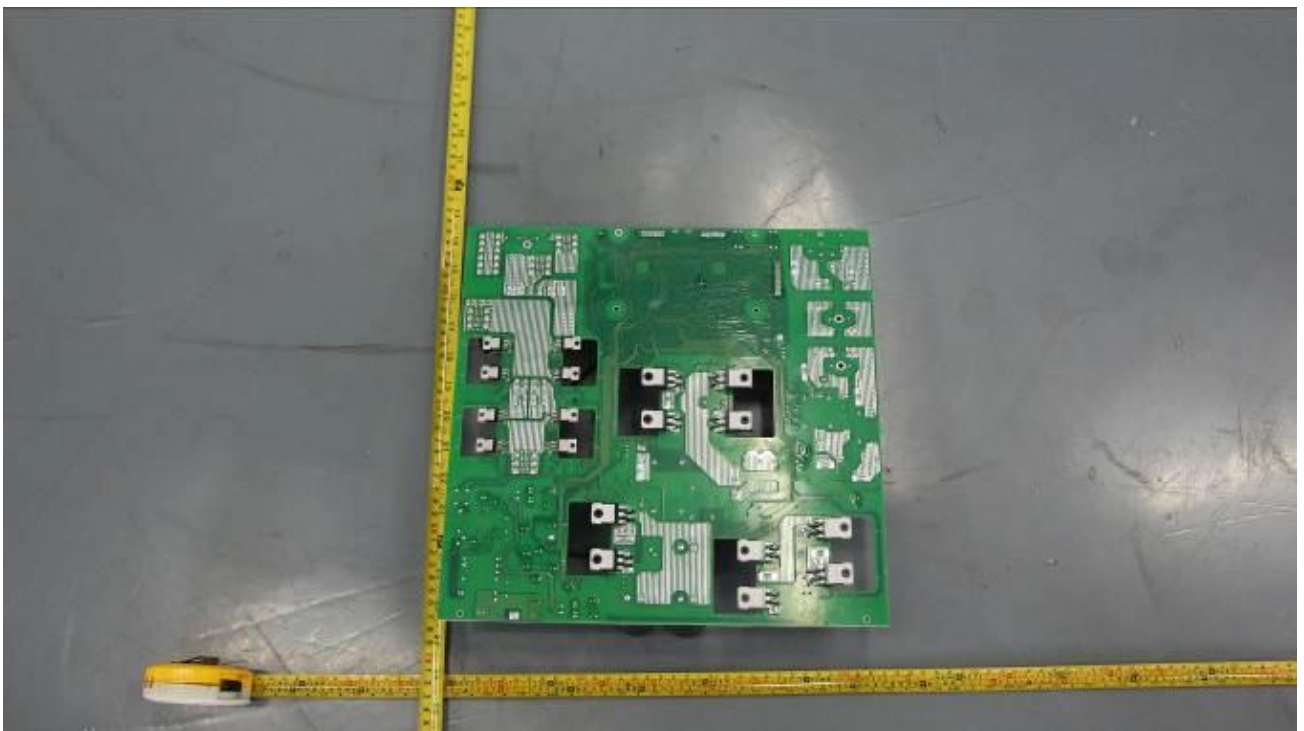

Soldered view

(End of Report)